

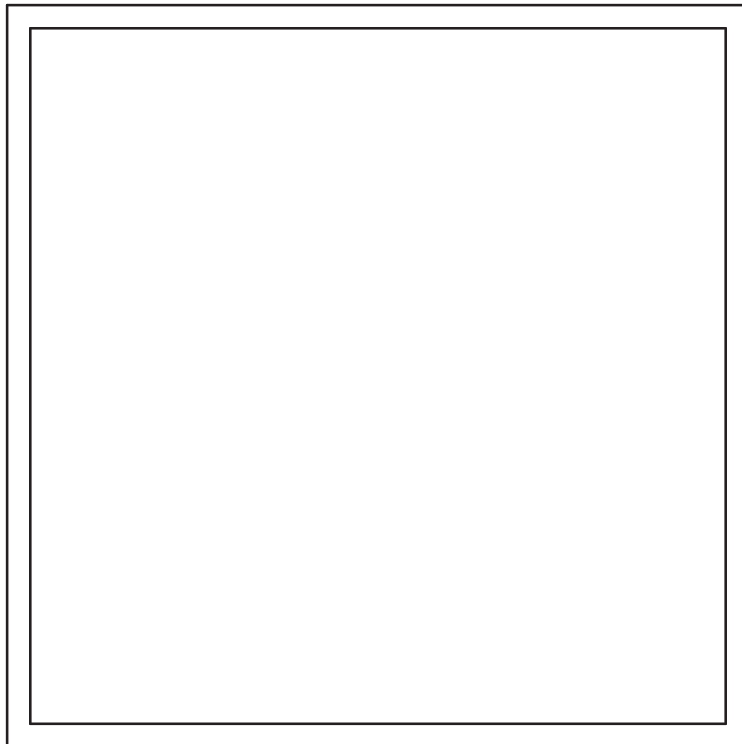

Shower Niches

Model #NI-1212-GMB, NI-1212-MB, NI-1212-SSB
PW-91212-83NIGMB, PW-91212-83NIBM, PW-91212-83NIBSS



Niche

Please Read The Following Instructions COMPLETELY Before Beginning!

Our goal is to ensure your installation goes smoothly and safely. Please read these instructions carefully and follow recommendations for plumbing and mounting. After reading instructions, if you determine you do not have the necessary skills and/or tools, we recommend that a licensed plumbing contractor complete the installation.

If you encounter any problems during installation
PLEASE VISIT CUSTOMER SUPPORT AT
WWW.PULSESHOWERSPAS.COM
Before returning your niche to the store

You Will Need The Following Tools

Soft pencil or felt pen to mark tile
Safety glasses
Reciprocating saw w/metal cutting blade
(Sawzall®)
Measuring Tape
Level

Dimensions

BEFORE YOU BEGIN: Measure the following to ensure your niche will fit properly.

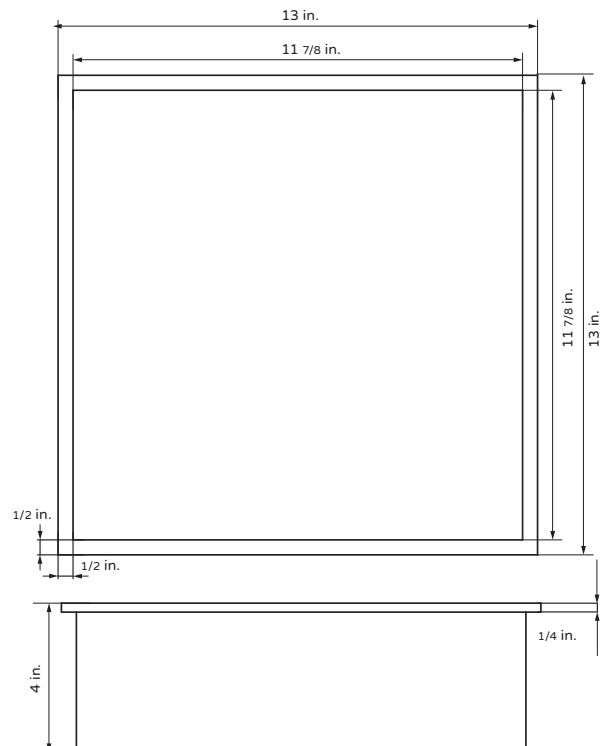

Installation Instructions

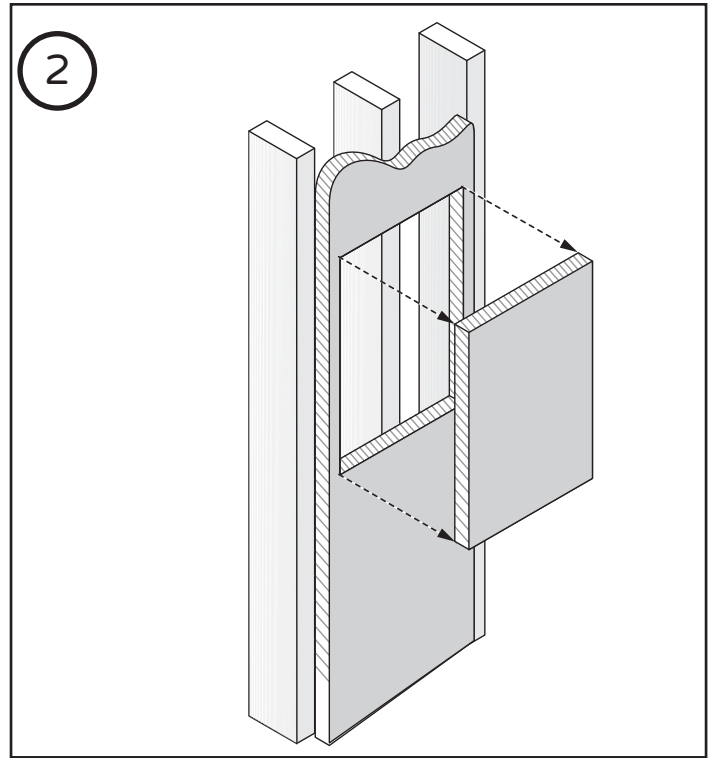
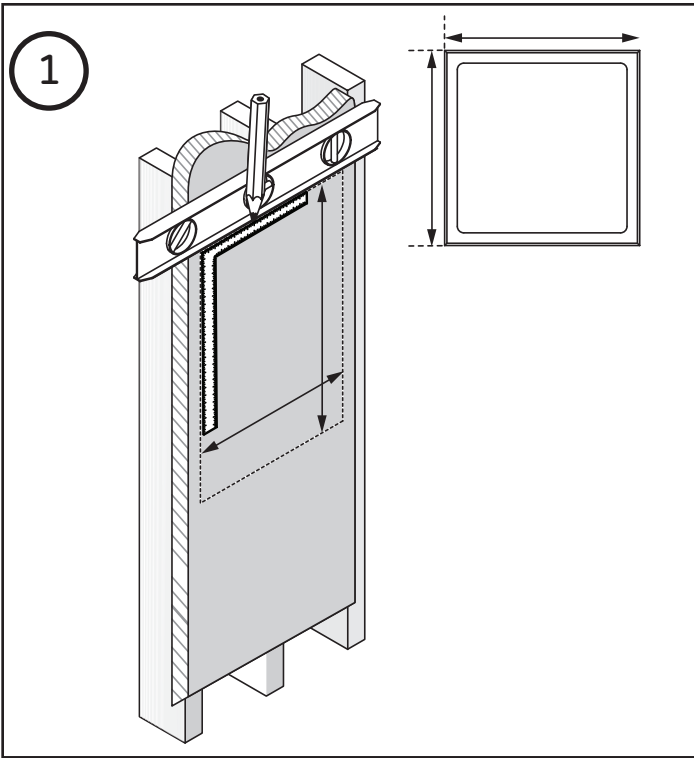

Prepare an opening between the uprights according to the dimensions X and Y of your niche, minus 1/4" (6mm). Ideally, when you insert your niche, it should offer a little resistance in the drywall to prevent it from moving until the silicone dries completely. If you have added another ceramic style finish, make it finish slightly shorter than the drywall.

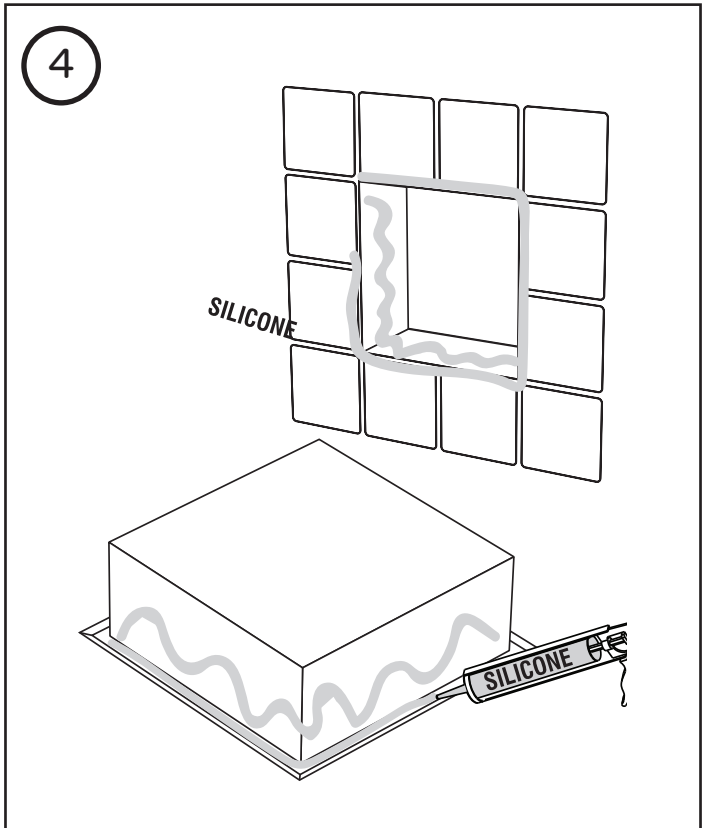
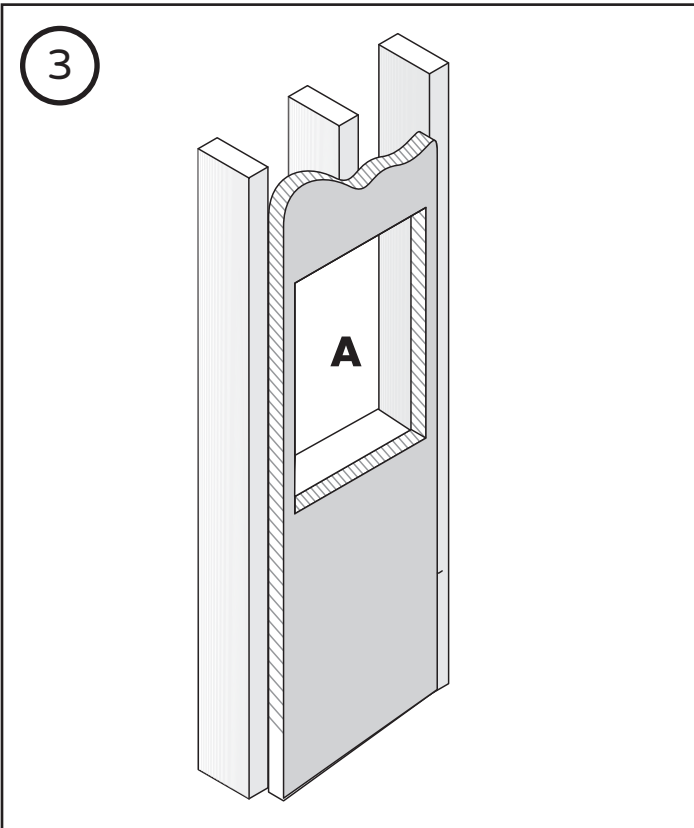

You will need to install wall supports all around the niche (A) in order to support it adequately.

Generously apply silicone on all sides, on the inner surface of the edge of the niche, on the wall, and on the uprights (as illustrated) for optimal sealing support.

Installation Instructions

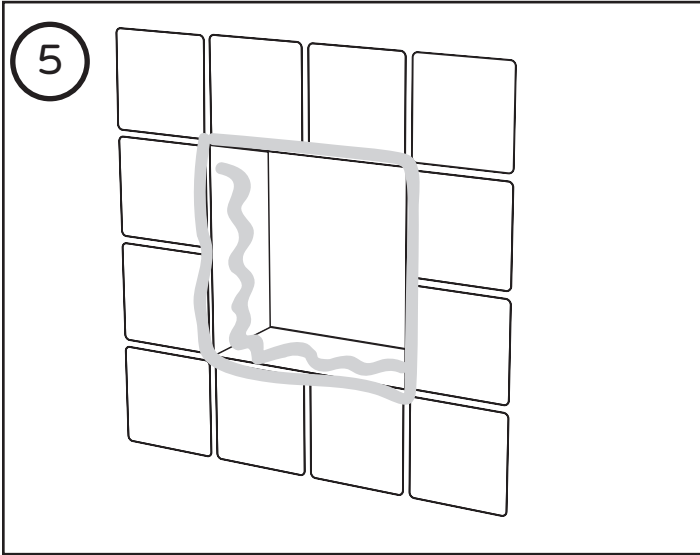

5 Place the niche against the wall and press firmly. Remove the niche and add silicone if it does protrude slightly.

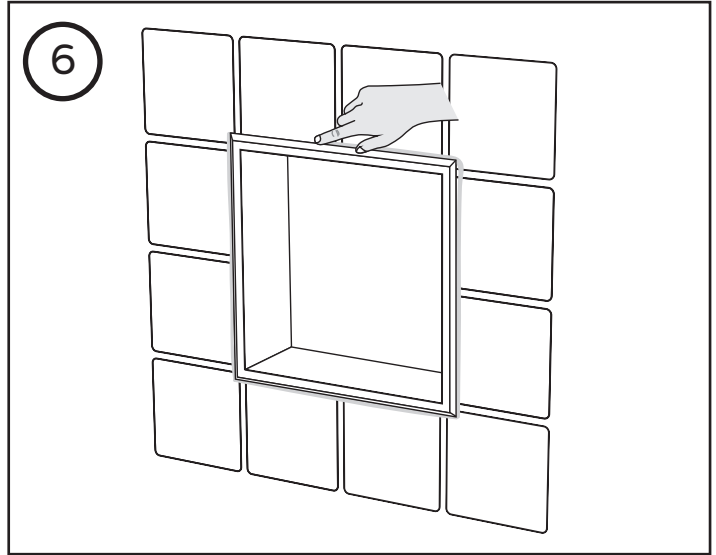

6 With a wet finger, wipe off any excess silicone.

Usage

Make sure to measure your niche model, as all models have different dimensions.

Allow silicone to dry completely before using/wetting.

DO NOT use any part of the niche as a support device.

Care and Maintenance

To keep your niche looking new, wipe down after each use with a soft cotton cloth.

Protect your niche from hard water stains and mineral deposits by periodically using an auto spray wax.

Clean using mild liquid soap and a non-abrasive sponge or cloth. Rinse with clean water.

**Do Not Use Any Kind Of
Chemicals Or Abrasives!**

MANUFACTURER'S LIFETIME LIMITED WARRANTY

1. Defects Covered; Warranty Period: Pulse Shower Spas, Inc. ("Pulse") warrants to the original consumer purchaser who purchases this shower spa (the "Product") for use in his or her own home, that the Product will be free from defects in material and manufacturing workmanship for as long as the original consumer purchaser owns that same home. For all other purchasers (including, but not limited to purchasers for industrial, commercial and business use), the above warranty will apply for a period of 5 years from the original date of purchase.

2. Remedy: If the Product does not conform to the above warranty, Pulse, at its option, will repair or replace the Product, free of charge, or refund your purchase price. For warranty claims, please visit www.pulshowerspas.com/index.php/warranty. Pulse may require that you return the Product to Pulse, shipping prepaid, in which case Pulse will provide you with a return materials authorization number (RMA). Pulse may also require that you provide evidence of the date you purchased the Product. Pulse will ship a new or repaired Product to you, at the expense of Pulse, or refund your purchase price. Service labor performed by you or others in connection with the removal or replacement of the Product will not be reimbursed by Pulse.

3. Exclusions: Pulse shall not be responsible for failure of the Product, and the above warranties will not apply, if the Product fails as a result of improper installation, improper use, modifications or repairs by anyone other than Pulse, or accident or abuse (including damage during shipment).

4. Warranty on Repairs and Replacements: For consumer purchasers who purchased the Product for home use, repaired or replacement Products will continue to be covered under this warranty for as long as he or she owns that same home. For other purchasers, repaired or replacement Products will be covered for the balance of the original warranty period.

5. No Other Warranties; Limitation of Liability: OTHER THAN THE LIFETIME LIMITED WARRANTY STATED ABOVE, PULSE DISCLAIMS ALL OTHER WARRANTIES, EXPRESS OR IMPLIED, INCLUDING BUT NOT LIMITED TO WARRANTIES OF MERCHANTABILITY AND FITNESS FOR A PARTICULAR PURPOSE, TO THE EXTENT PERMITTED BY APPLICABLE LAW. THE REMEDIES STATED ABOVE ARE YOUR SOLE REMEDIES IN CONNECTION WITH THIS WARRANTY. IN NO EVENT WILL PULSE BE LIABLE TO YOU FOR ANY DAMAGES, WHETHER DIRECT, INDIRECT, INCIDENTAL, SPECIAL OR CONSEQUENTIAL, INCLUDING BUT NOT LIMITED TO LOST PROFITS OR BUSINESS INTERRUPTION, ARISING OUT OF OR RELATING TO THE PRODUCT OR ITS USE, WHETHER UNDER A CONTRACT, WARRANTY, TORT, OR ANY OTHER CAUSE OF ACTION, EVEN IF PULSE HAS BEEN ADVISED OF THE POSSIBILITY OF SUCH DAMAGES. NOTWITHSTANDING THE TERM OF ANY LIMITED OR IMPLIED WARRANTY, OR IN THE EVENT THAT ANY LIMITED WARRANTY FAILS OF ITS ESSENTIAL PURPOSE, IN NO EVENT WILL PULSE'S ENTIRE LIABILITY EXCEED THE PURCHASE PRICE OF THE PRODUCT. SOME STATES AND PROVINCES DO NOT ALLOW THE EXCLUSION OR LIMITATION OF INCIDENTAL OR CONSEQUENTIAL DAMAGES SO THE ABOVE LIMITATIONS OR EXCLUSIONS MAY NOT APPLY TO YOU. THIS LIMITED WARRANTY GIVES YOU SPECIFIC LEGAL RIGHTS, AND YOU MAY ALSO HAVE OTHER RIGHTS WHICH VARY FROM STATE TO STATE AND PROVINCE TO PROVINCE.