



Tropicana ShowerSpa
Model #1039W-BN

PW-91039-5625SFBSS & PW-91039-5618SFBSS

Owner's Manual



Please Read The Following Instructions
COMPLETELY Before Beginning!

Our goal is to ensure your installation goes smoothly and safely. Please read these instructions carefully and follow recommendations for plumbing and mounting. After reading instructions, if you determine you do not have the necessary skills and/or tools, we recommend that a licensed plumbing contractor complete the installation.

If you encounter any problems during installation
PLEASE VISIT CUSTOMER SUPPORT AT
WWW.PULSESHOWERSPAS.COM
Before returning your ShowerSpa to the store

You Will Need The Following Tools

Soft pencil or felt pen to mark tile

4mm & 5mm allen wrench

Safety glasses

Tape measure

Level

Channel locks or adjustable wrench

Drill (preferably cordless)

Masonry drill bit

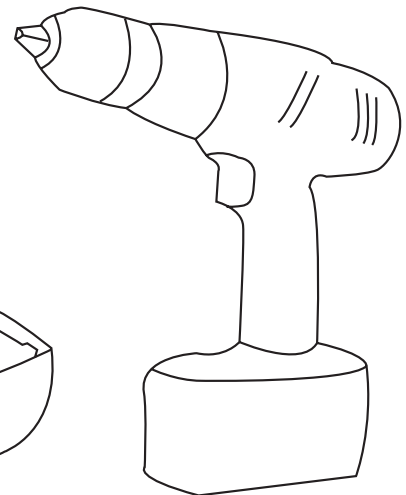
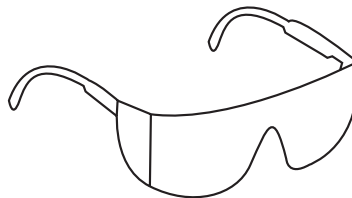
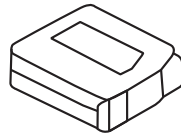
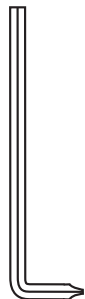
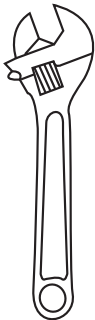

Product Dimensions

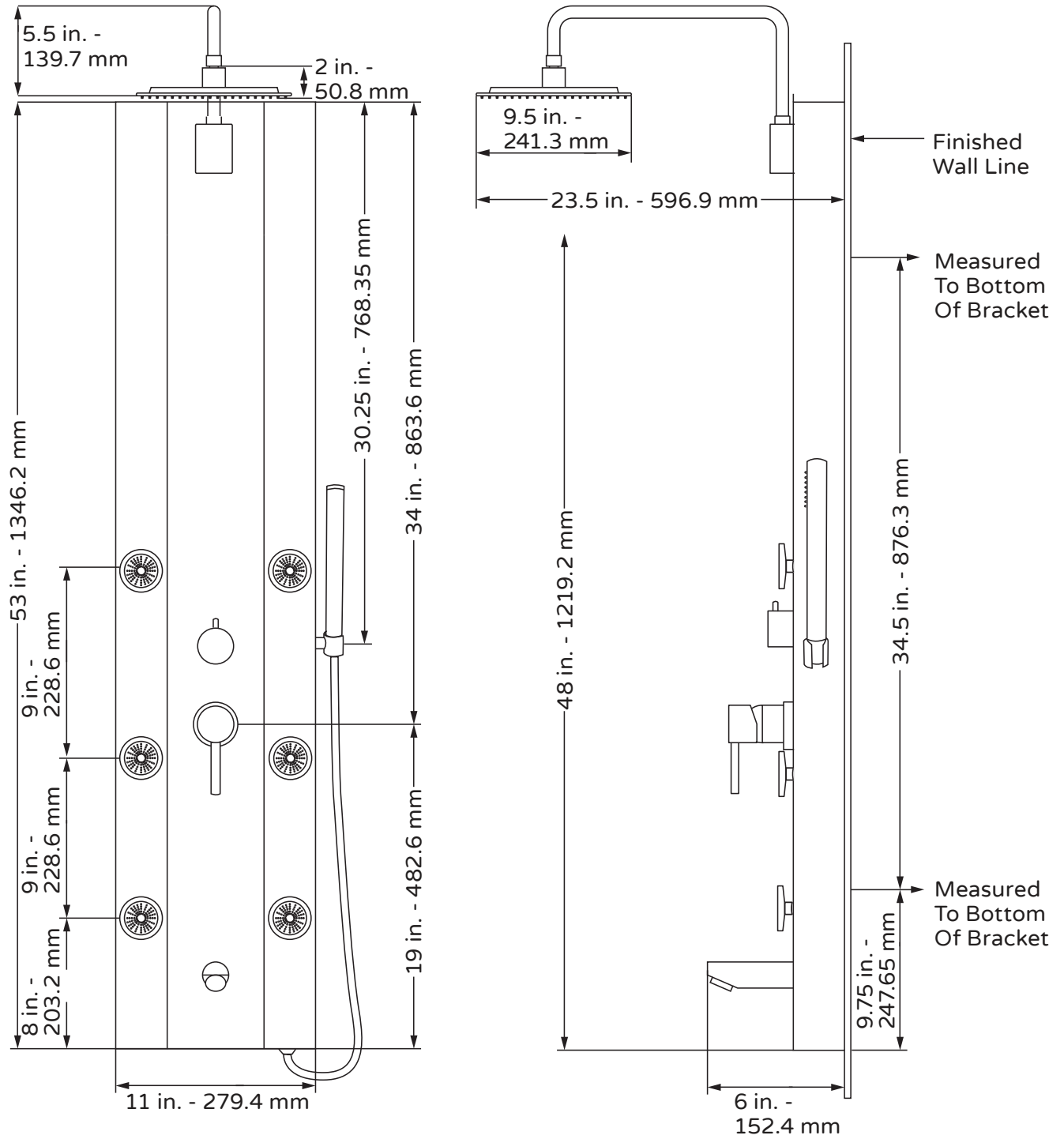

Parts Legend

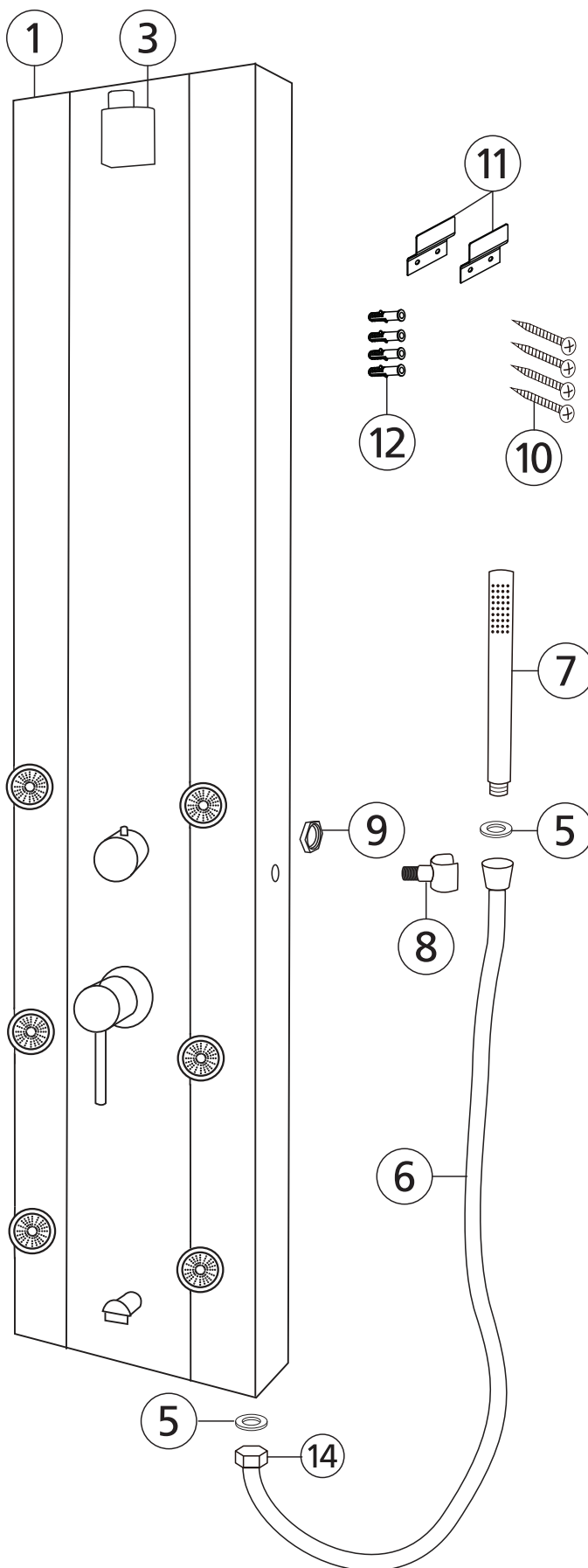
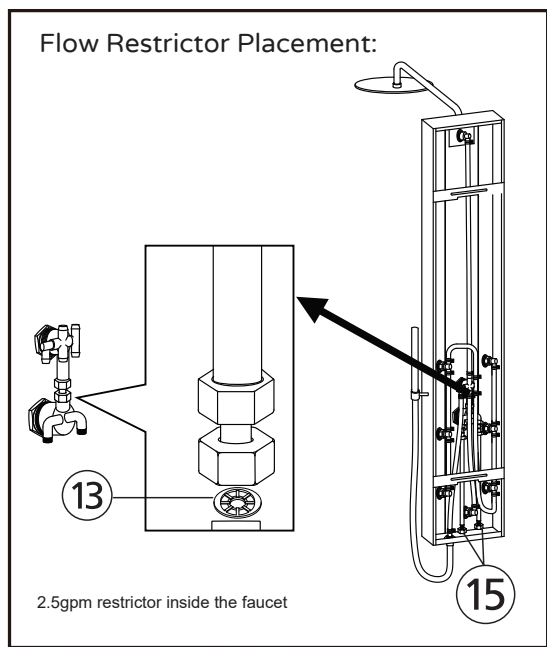
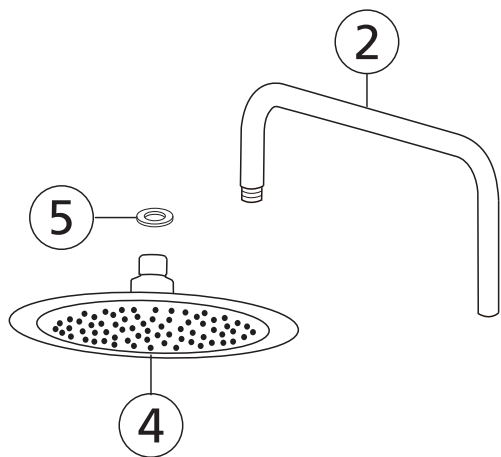

1. ShowerSpa
2. Shower Arm
3. Shower Arm Base
4. Showerhead
5. Rubber Washer.....8 (4 extra)
6. Handshower Hose
7. Handshower
8. Handshower Holder
9. Handshower Holder Nut
10. Mounting Screw.....4
11. Wall Mount Bracket.....2
12. Nylon Wall Anchor.....4
13. Water Restrictor
14. Built-In Check Valve
15. Supply Line

Assembly

After unpacking your ShowerSpa, some assembly is required prior to installation.

Shower Arm Assembly

Attach shower arm to the shower arm base and secure.

Handshower Holder Assembly

NOTE—The handshower holder is directional and must be installed so the set screw is facing down in order for the tapered end of the hose to fit properly.

1. Use 4mm allen wrench to remove allen bolt from handshower holder and retain lock washer. Insert bolt through lock washer, then opening on side of ShowerSpa. Tighten bolt to holder while adjusting its' position (we recommend a slight forward angle).
2. Secure set screw on bottom side of holder to lock in place.

After ShowerSpa is mounted to the wall

Handshower Assembly

1. Insert washer (5) into hexagon shaped end of handshower hose (6) and attach to threaded outlet on bottom of ShowerSpa. Do not over-tighten.
2. Insert washer (5) into tapered end of handshower hose (6) and attach to handshower (7). Insert handshower (7) into hanger.
3. Check that rubber screen washer (5) is in showerhead (4) and screw showerhead onto the shower arm (2).

Installation – New Construction

Extensive Remodel – New Finished Wall Surface

1. Prior to sheetrock, stub-out $\frac{1}{2}$ " hot and cold supply lines beyond finished wall surface, 4" on center. For best results, attach 90° brass fittings (available at most hardware stores) to the stub-outs maintaining $\frac{1}{4}$ " – $\frac{1}{2}$ " of space between the fitting and finished wall. The open end of the 90° brass fittings should point down so the supply lines attach parallel to the wall.¹
2. For a person 5'8" – 6'2" we recommend the stub-outs be 40" above finished floor.²
3. Before installation, make certain that water is COMPLETELY TURNED OFF to both hot & cold supply lines of shower.
- 4a. Mark location of holes for the mounts, making sure holes are plumb. For a person 5'8" – 6'2", we recommend placing the top hole of the upper mount at approx. 71" above finished floor.³
- 4b. Determine location for the lower mount. Measure the distance between indents on the bottom edges of the two brackets on back of ShowerSpa (approx. 35 $\frac{1}{2}$ "). Using this distance, measure down from the top hole in upper mount to get the location of the top hole in lower mount.
- 4c. Use the mounts to mark only one of the lower holes in each mount, whichever is most convenient.
5. Before drilling holes, make certain that connecting to stub-outs DOES NOT INTERFERE with backside of ShowerSpa and it is flush with finished wall at desired mounting height.²
6. Drill $\frac{1}{4}$ " holes through wall surface using a masonry bit. Drill slowly through wall surface to avoid cracking and chipping. Insert anchors and securely screw brackets to wall. Before connecting hot and cold supply lines, hang the ShowerSpa on wall, check the height and make sure the ShowerSpa is flush against wall with a secure fit.
7. Connect hot and cold water supply lines to stub-outs—DO NOT OVERTIGHTEN. Before mounting the ShowerSpa, check fittings to make sure they are secure. Turn on water and check for leaks. When fittings are leak-free, mount ShowerSpa on wall.
8. OPTIONAL—Seal around body of ShowerSpa with a bead of silicone. DO NOT SEAL BOTTOM.

Retrofit – Existing Shower Replacement

NOTE—In a remodel in which you are not replacing the finished wall surface (tile, or backing material) it is advisable to purchase a PULSE ShowerSpa model that covers the location of your existing valve assembly—either single handle or two-handle type. If your PULSE ShowerSpa model does not cover this area, you will need to either choose another PULSE ShowerSpa model that does or make necessary repairs with appropriate materials (i.e. wallboard, tile, fiberglass, etc).

1. TURN OFF WATER SUPPLY TO SHOWER. Typically there is a gate valve where the water main enters the house. Turning the water valve off at hot water tank does not turn off cold water supply line.
2. Make certain water is completely turned off to both hot & cold supply lines of shower. Turn shower valve on, both hot and cold, to VERIFY WATER SUPPLY IS OFF. Open a sink faucet in the bathroom in which you are installing the ShowerSpa to relieve any pressure and help adequately drain shower supply lines.
3. Remove handle(s) and trim cover(s) of your existing shower valve, exposing valve body in wall.
4. Locate hot and cold supply lines entering valve. Using a reciprocating saw with sharp metal saw blade, cut existing valve out, preserving threads of the supply lines entering valve. You should also cut the riser within wall supplying the existing showerhead. Carefully twist and remove valve.
5. Unscrew old showerhead from shower arm, then unscrew shower arm from wall.
6. Water lines must be extended to the outside of wall cavity, 4" on center. For best results, attach 90° brass fittings (available at most hardware stores) to the stub-outs maintaining $\frac{1}{4}$ " – $\frac{1}{2}$ " of space between the fitting and finished wall. The open end of the 90° brass fittings should point down so the supply lines attach parallel to the wall.¹
- 7a. Mark location of holes for the mounts, making sure holes are plumb. For a person 5'8" – 6'2", we recommend placing the top hole of the upper mount at approx. 71" above finished floor.³
- 7b. Determine location for the lower mount. Measure the distance between indents on the bottom edges of the two brackets on back of ShowerSpa (approx. 35 $\frac{1}{2}$ "). Using this distance, measure down from the top hole in upper mount to get the location of the top hole in lower mount.
- 7c. Use the mounts to mark only one of the lower holes in each mount, whichever is most convenient.
8. Before drilling holes, make certain that connecting to stub-outs DOES NOT INTERFERE with backside of ShowerSpa and it is flush with finished wall at desired mounting height.²
9. Drill $\frac{1}{4}$ " holes through wall surface using a masonry bit. Drill slowly through wall surface to avoid cracking and chipping. Insert anchors and securely screw brackets to wall. Before connecting hot and cold supply lines, hang ShowerSpa on wall, check the height and make sure ShowerSpa is flush against the wall with a secure fit.
10. Connect hot and cold water supply lines to stub-outs—DO NOT OVERTIGHTEN. Before mounting the ShowerSpa, check fittings to make sure they are secure. Turn on water and check for leaks. When fittings are leak-free, mount ShowerSpa on wall.
11. OPTIONAL—Seal around body of ShowerSpa with a bead of silicone. DO NOT SEAL BOTTOM.

¹ Additional fittings or longer supply lines may be necessary depending on your specific situation.

² The desired mounting height of ShowerSpa determines, or is determined by location of the $\frac{1}{2}$ " stub-outs.

³ The mounting height can vary depending on several factors (i.e. location of supply lines, interference from ShowerSpa plumbing, old valve access area, personal preference, etc.)

Installation – New Construction

Extensive Remodel – New Finished Wall Surface

1. Prior to sheetrock, stub-out $\frac{1}{2}$ " hot and cold supply lines beyond finished wall surface, 4" on center. For best results, attach 90° brass fittings (available at most hardware stores) to the stub-outs maintaining $\frac{1}{4}$ " – $\frac{1}{2}$ " of space between the fitting and finished wall. The open end of the 90° brass fittings should point down so the supply lines attach parallel to the wall.¹
2. For a person 5'8" – 6'2" we recommend the stub-outs be 40" above finished floor.²
3. Before installation, make certain that water is COMPLETELY TURNED OFF to both hot & cold supply lines of shower.
- 4a. Mark location of holes for the mounts, making sure holes are plumb. For a person 5'8" – 6'2", we recommend placing the top hole of the upper mount at approx. 71" above finished floor.³
- 4b. Determine location for the lower mount. Measure the distance between indents on the bottom edges of the two brackets on back of ShowerSpa (approx. 35 $\frac{1}{2}$ "). Using this distance, measure down from the top hole in upper mount to get the location of the top hole in lower mount.
- 4c. Use the mounts to mark only one of the lower holes in each mount, whichever is most convenient.
5. Before drilling holes, make certain that connecting to stub-outs DOES NOT INTERFERE with backside of ShowerSpa and it is flush with finished wall at desired mounting height.²
6. Drill $\frac{1}{4}$ " holes through wall surface using a masonry bit. Drill slowly through wall surface to avoid cracking and chipping. Insert anchors and securely screw brackets to wall. Before connecting hot and cold supply lines, hang the ShowerSpa on wall, check the height and make sure the ShowerSpa is flush against wall with a secure fit.
7. Connect hot and cold water supply lines to stub-outs—DO NOT OVERTIGHTEN. Before mounting the ShowerSpa, check fittings to make sure they are secure. Turn on water and check for leaks. When fittings are leak-free, mount ShowerSpa on wall.
8. OPTIONAL—Seal around body of ShowerSpa with a bead of silicone. DO NOT SEAL BOTTOM.

Retrofit – Existing Shower Replacement

NOTE—In a remodel in which you are not replacing the finished wall surface (tile, or backing material) it is advisable to purchase a PULSE ShowerSpa model that covers the location of your existing valve assembly—either single handle or two-handle type. If your PULSE ShowerSpa model does not cover this area, you will need to either choose another PULSE ShowerSpa model that does or make necessary repairs with appropriate materials (i.e. wallboard, tile, fiberglass, etc).

1. TURN OFF WATER SUPPLY TO SHOWER. Typically there is a gate valve where the water main enters the house. Turning the water valve off at hot water tank does not turn off cold water supply line.
2. Make certain water is completely turned off to both hot & cold supply lines of shower. Turn shower valve on, both hot and cold, to VERIFY WATER SUPPLY IS OFF. Open a sink faucet in the bathroom in which you are installing the ShowerSpa to relieve any pressure and help adequately drain shower supply lines.
3. Remove handle(s) and trim cover(s) of your existing shower valve, exposing valve body in wall.
4. Locate hot and cold supply lines entering valve. Using a reciprocating saw with sharp metal saw blade, cut existing valve out, preserving threads of the supply lines entering valve. You should also cut the riser within wall supplying the existing showerhead. Carefully twist and remove valve.
5. Unscrew old showerhead from shower arm, then unscrew shower arm from wall.
6. Water lines must be extended to the outside of wall cavity, 4" on center. For best results, attach 90° brass fittings (available at most hardware stores) to the stub-outs maintaining $\frac{1}{4}$ " – $\frac{1}{2}$ " of space between the fitting and finished wall. The open end of the 90° brass fittings should point down so the supply lines attach parallel to the wall.¹
- 7a. Mark location of holes for the mounts, making sure holes are plumb. For a person 5'8" – 6'2", we recommend placing the top hole of the upper mount at approx. 71" above finished floor.³
- 7b. Determine location for the lower mount. Measure the distance between indents on the bottom edges of the two brackets on back of ShowerSpa (approx. 35 $\frac{1}{2}$ "). Using this distance, measure down from the top hole in upper mount to get the location of the top hole in lower mount.
- 7c. Use the mounts to mark only one of the lower holes in each mount, whichever is most convenient.
8. Before drilling holes, make certain that connecting to stub-outs DOES NOT INTERFERE with backside of ShowerSpa and it is flush with finished wall at desired mounting height.²
9. Drill $\frac{1}{4}$ " holes through wall surface using a masonry bit. Drill slowly through wall surface to avoid cracking and chipping. Insert anchors and securely screw brackets to wall. Before connecting hot and cold supply lines, hang ShowerSpa on wall, check the height and make sure ShowerSpa is flush against the wall with a secure fit.
10. Connect hot and cold water supply lines to stub-outs—DO NOT OVERTIGHTEN. Before mounting the ShowerSpa, check fittings to make sure they are secure. Turn on water and check for leaks. When fittings are leak-free, mount ShowerSpa on wall.
11. OPTIONAL—Seal around body of ShowerSpa with a bead of silicone. DO NOT SEAL BOTTOM.

¹ Additional fittings or longer supply lines may be necessary depending on your specific situation.

² The desired mounting height of ShowerSpa determines, or is determined by location of the $\frac{1}{2}$ " stub-outs.

³ The mounting height can vary depending on several factors (i.e. location of supply lines, interference from ShowerSpa plumbing, old valve access area, personal preference, etc.)

MANUFACTURER'S LIFETIME LIMITED WARRANTY

1. Defects Covered; Warranty Period: Pulse Shower Spas, Inc. ("Pulse") warrants to the original consumer purchaser who purchases this shower spa (the "Product") for use in his or her own home, that the Product will be free from defects in material and manufacturing workmanship for as long as the original consumer purchaser owns that same home. For all other purchasers (including, but not limited to purchasers for industrial, commercial and business use), the above warranty will apply for a period of 5 years from the original date of purchase.

2. Remedy: If the Product does not conform to the above warranty, Pulse, at its option, will repair or replace the Product, free of charge, or refund your purchase price. For warranty claims, please visit www.pulshower spas.com/index.php/warranty. Pulse may require that you return the Product to Pulse, shipping prepaid, in which case Pulse will provide you with a return materials authorization number (RMA). Pulse may also require that you provide evidence of the date you purchased the Product. Pulse will ship a new or repaired Product to you, at the expense of Pulse, or refund your purchase price. Service labor performed by you or others in connection with the removal or replacement of the Product will not be reimbursed by Pulse.

3. Exclusions: Pulse shall not be responsible for failure of the Product, and the above warranties will not apply, if the Product fails as a result of improper installation, improper use, modifications or repairs by anyone other than Pulse, or accident or abuse (including damage during shipment).

4. Warranty on Repairs and Replacements: For consumer purchasers who purchased the Product for home use, repaired or replacement Products will continue to be covered under this warranty for as long as he or she owns that same home. For other purchasers, repaired or replacement Products will be covered for the balance of the original warranty period.

5. No Other Warranties; Limitation of Liability: OTHER THAN THE LIFETIME LIMITED WARRANTY STATED ABOVE, PULSE DISCLAIMS ALL OTHER WARRANTIES, EXPRESS OR IMPLIED, INCLUDING BUT NOT LIMITED TO WARRANTIES OF MERCHANTABILITY AND FITNESS FOR A PARTICULAR PURPOSE, TO THE EXTENT PERMITTED BY APPLICABLE LAW. THE REMEDIES STATED ABOVE ARE YOUR SOLE REMEDIES IN CONNECTION WITH THIS WARRANTY. IN NO EVENT WILL PULSE BE LIABLE TO YOU FOR ANY DAMAGES, WHETHER DIRECT, INDIRECT, INCIDENTAL, SPECIAL OR CONSEQUENTIAL, INCLUDING BUT NOT LIMITED TO LOST PROFITS OR BUSINESS INTERRUPTION, ARISING OUT OF OR RELATING TO THE PRODUCT OR ITS USE, WHETHER UNDER A CONTRACT, WARRANTY, TORT, OR ANY OTHER CAUSE OF ACTION, EVEN IF PULSE HAS BEEN ADVISED OF THE POSSIBILITY OF SUCH DAMAGES. NOTWITHSTANDING THE TERM OF ANY LIMITED OR IMPLIED WARRANTY, OR IN THE EVENT THAT ANY LIMITED WARRANTY FAILS OF ITS ESSENTIAL PURPOSE, IN NO EVENT WILL PULSE'S ENTIRE LIABILITY EXCEED THE PURCHASE PRICE OF THE PRODUCT. SOME STATES AND PROVINCES DO NOT ALLOW THE EXCLUSION OR LIMITATION OF INCIDENTAL OR CONSEQUENTIAL DAMAGES SO THE ABOVE LIMITATIONS OR EXCLUSIONS MAY NOT APPLY TO YOU. THIS LIMITED WARRANTY GIVES YOU SPECIFIC LEGAL RIGHTS, AND YOU MAY ALSO HAVE OTHER RIGHTS WHICH VARY FROM STATE TO STATE AND PROVINCE TO PROVINCE.

